



art metal

# 18 JOWISZ (ODB-10)

F.P.H. Art Metal Sp.j.

Ul. Jabłoniowa 124, 83-331 Łapino Kartuskie, Poland  
Tel. 0048 58 681 80 78, Fax: 0048 58 681 80 64  
www.art-metal.pl e-mail: biuro@art-metal.pl

### Construcion:

The unit consists of a metal base (1) which holds a shade (2). The shade is sealed by ring gasket (3) from the bottom. A reflector ODB-10 (4) is attached to the shade. A tray (5) with an igniter module (6) and lampholder (7) are mounted on the reflector. The metal shade (2) is closed with a decorative top cover (9). Gaskets (10) make the unit weather-tight. A lyre-shaped mounting holder mounted on the base from the bottom is used to attach the unit to a pole or a bracket.

### Mounting instruction:

- \*) -Put the shade (2) into the base (1), keeping it tight against the frame with the gaskets (3).
- \*) -Attach the tray (5) with the igniter (6) and the lampholder (7) to the reflector (4).
- Attach the reflector (4) and the decorative top cover (9) to the shade (1).
- Put the lamp (9) in position.
- Connect the electrical cables to the terminals of igniter (6).

IP 44  
IP 65

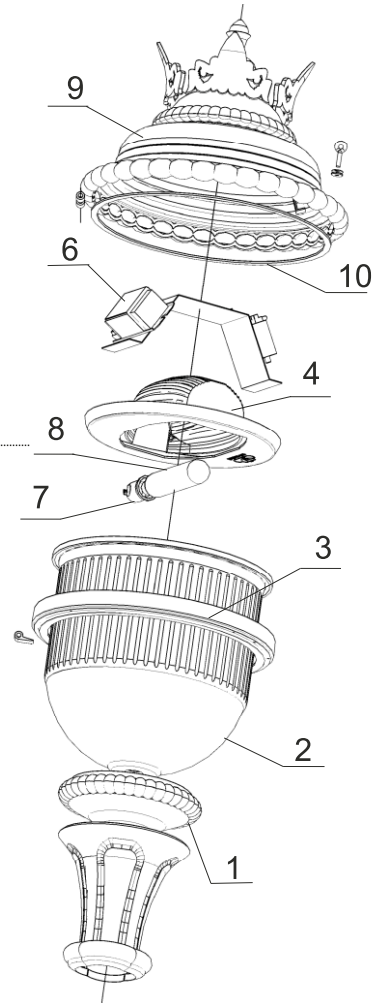

If any lantern elements are supplied factory-mounted, the mounting stages marked with \*) should be omitted (as this has already been done by the manufacturer)

### TECHNICAL DATA:

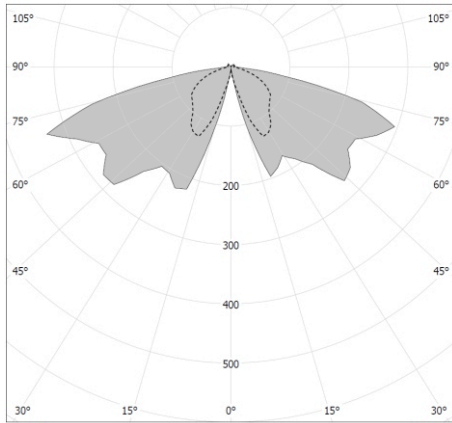

cd/klm C0 - C180 ..... C90 - C270  
Photometry (polar plot)

Power: ~230/50Hz

Protective class: I

IP44 - electrical part

IP65 - optical part

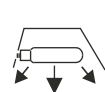
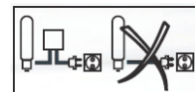

### ELECTRICAL DIAGRAM:

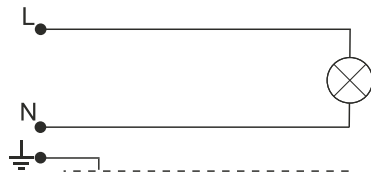

1. Incandescent bulb

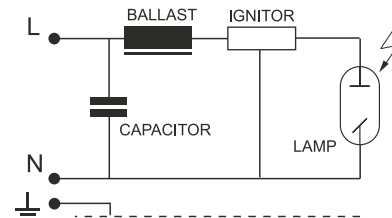

2. Sodium / metal halide lamps

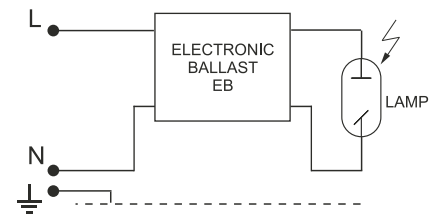

3. Sodium / metal halide lamps

Type	Light-producing element	Lamp holder	Weight [kg]	Pn [W]		Luminary dimensions
				IC	EB	
18MH-70W	MH/HSI/HPI	E27	13,7	81	75	 Wind area A = 0,23m <sup>2</sup> H/D 940/460
18MH-100W	MH/HSI/HPI	E27	13,8	114	105	
18MH-150W	MH/HSI/HPI	E27	14,5	169	155	
18S-70W	WLS/SHP/SON	E27	13,9	81	75	
18S-100W	WLS/SHP/SON	E40	14,0	114	105	
18S-150W	WLS/SHP/SON	E40	14,7	169	155	
18Z-E/Z	Bulb / MINI - LINX	E27	12,4	Maks. 60		

**WARNING !!** The weight of the unit may slightly differ for individual production batches.

Sign:L-0018-01-02

Last revision: 2016.01.27

